



WINDOW PRODUCTS LIMITED

Effective solutions for windows manufacturers and fitters

Unit 4203 Oakfield Close,
Tewkesbury Business Park,
Tewkesbury, Glos
GL20 8PF

T: 01684 290944

E: sales@gtwindowproducts.co.uk

W: www.gtwindowproducts.co.uk

GT Snap-Lok

Patent Applied

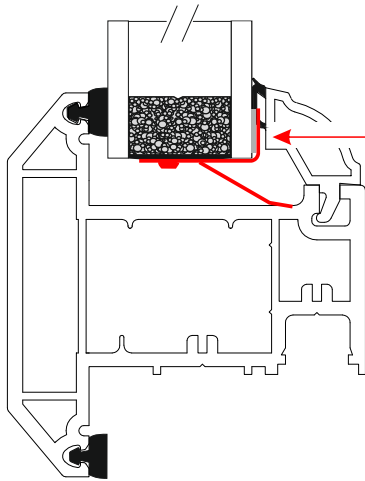

SK001 & ZPadSK
For 28mm units

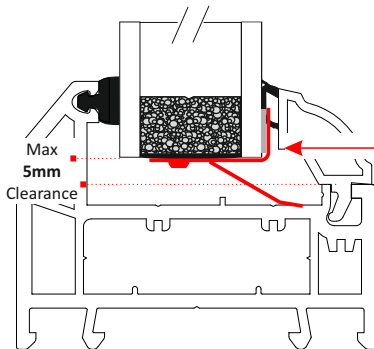

SK001 & ZPadSK
For 28mm units

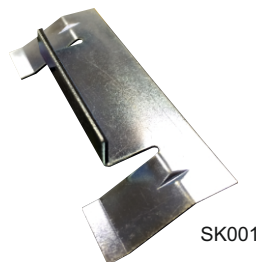
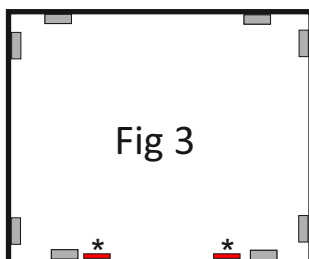
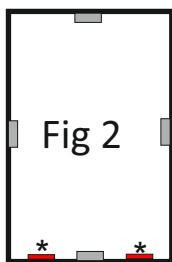
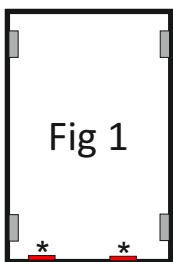

SK001

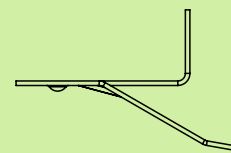

SK001
For 28mm units

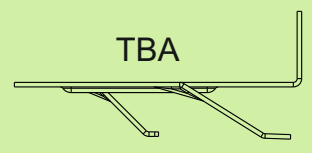

TBA
SK003
For 36mm units



ZPadSK

The GT Snap-Lok is a clip system for retaining glass units on internally glazed windows and doors.

This innovative designed clip, when fitted in the appropriate numbers and positions, will assist windows and doors to meet the requirements for PAS24.

For 28mm unit up to 900mm width and 1200 height fit a minimum of 4 GT Snap Loks as shown in Fig.1 and Fig.2

For unit sizes larger that this then it is advisable to fit additional clips as shown in Fig.3

Fit glazing packers on the bottom rail shown marked *, and place the glass unit into the frame.

Attach a ZPadSK to each clip and remove the blue cover paper. This will now allow the clip to stick to the unit when in position.

Push all GT Snap Lok clips into place prior to packing the unit.

